



LET'S GET
STARTED



Smoke Alarm

Instruction manual



TABLE OF CONTENTS

1.0 PRODUCT DESCRIPTION.....	4
1.1 Intended use	4
2.0 BOX CONTENTS	5
3.0 WARNING NOTICES.....	6
3.1 Explanation of symbols	6
3.2 Safety instructions	6
4.0 INDICATORS AND CONTROLS	7
4.1 Product overview	7
5.0 INSTALLATION AND SETUP.....	8
5.1 Installation	8
5.2 Activating the device	9
6.0 MOUNTING THE SMOKE ALARM	9
6.1 Mounting instructions	9
6.2 Fixing with screws	11
6.3 Fixing with adhesive tapes	12
6.4 Functional test	14
7.0 MAINTENANCE INSTRUCTIONS.....	14
7.1 Visual inspection	14
8.1 Switching off the alarm	15
8.2 Faults and measures	15
9.0 PRODUCT DETAILS	16
9.1 Technical data	16
9.2 Declaration of conformity	17
9.3 Faults in radio operation	17
9.4 Open-source software	17
9.5 Environmental protection and disposal	18
10.0 FURTHER INFORMATION	18

Dear customer,
Congratulations on purchasing your Bosch Smart Home Smoke Alarm. It will help you to make your home even safer and smarter. The Bosch Smart Home Smoke Alarm will warn you to potential fires in your home and the integrated light will illuminate the escape route.

The Bosch Smart Home Smoke Alarm is quickly and easily integrated into your Bosch Smart Home System, enabling you to receive alarm notifications via the Smart Home App to your smart device. When installed alongside Bosch Smart Home motion sensors and door window contacts the smoke alarm doubles as an intruder alarm to warn off unwanted guests.

We hope you enjoy your new product,
The Bosch Smart Home team

1.0 PRODUCT DESCRIPTION

The product is a radio-connectable smoke alarm to EN14604, which is equipped with the following components:

- ▶ Built-in audible alarm
 - On detection of smoke
 - On unauthorized entry (in conjunction with a motion sensor or door/window contact)
- ▶ Alarm LED
- ▶ Emergency light
- ▶ Large operating button
- ▶ Built-in long-life lithium battery

The product reliably warns you of potential fires in your home. If smoke is detected both a visual and audible alarm is triggered. Where more than one smoke alarm is connected to the Smart Home system if one alarm is triggered all connected alarms will sound.

1.1 Intended use

The product is intended for indoor use in residential buildings. It should only be used together with original Bosch Smart Home components.

- ▶ Follow the safety instructions and the directions in this manual and in the Bosch Smart Home App to ensure that the product is set up correctly
- ▶ Please note the details in the Technical Data section (see p. 16)
- ▶ Avoid installing in areas prone to high amounts of direct sunlight or near to sources of heat or cold

 Do not modify the product in any way. Any other use is considered unintended use. We will not assume liability for any resulting damage.

2.0 BOX CONTENTS

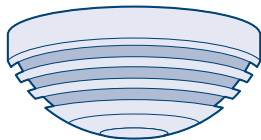

Smoke alarm

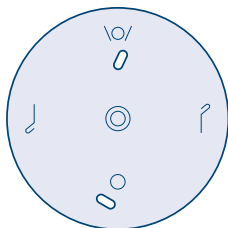

Mounting plate



2 plugs,
2 screws



Adhesive strip
(3M™ VHB™915/5925/5930/5952
adhesive tape)

i Batteries are supplied pre installed in the smoke alarm. Twisting into the mounting plate switches on the smoke alarm.

3.0 WARNING NOTICES

3.1 Explanation of symbols



Warning!

This alerts you to danger.



Info.

Indicates important information.

3.2 Safety instructions



Please do not open the smoke alarm. The product does not contain any user replaceable parts. The smoke alarm should not be dismantled. In case of fault, please contact our customer service team. Please observe the intended use.



The product should only be mounted using the material provided or recommended in this manual. Do not paint or wallpaper over any of the devices. It is recommended that you replace the device after 10 years.



Batteries must not be exposed to excessive heat such as sunlight, fire, etc.



The device is not a toy. Do not let children play with it. Do not leave packaging material lying around carelessly. Plastic film and small parts can become a dangerous toy for children.

Due to external circumstances such as a break in radio communication with the Smart Home Controller, it cannot always be guaranteed during remote or automated appliance control that commands are actually executed or the correct appliance status is displayed in the app and on other Smart Home display devices (e. g. a Twist). This may result in damage to property and/or injury.

In this case:

- ▶ Please ensure as far as possible that no-one is at risk during remote operation or automated control.
- ▶ Please exercise particular caution when setting up or adjusting a remote or automated control and regularly check the desired operation mode.

4.0 INDICATORS AND CONTROLS

4.1 Product overview

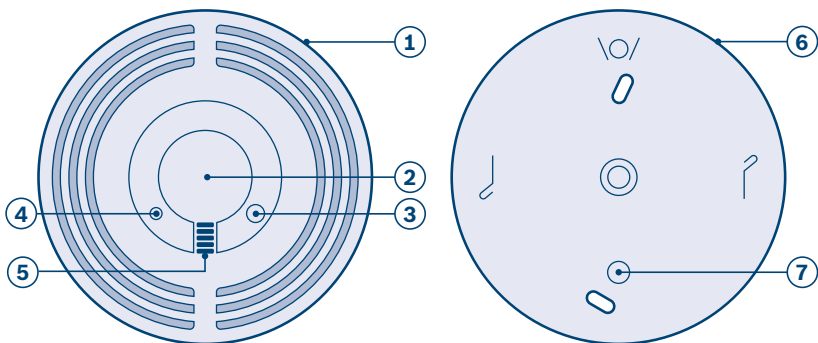

Item	Part	Explanation	
1	Smoke alarm	-	
2	Operating button	Accessing and confirming functions	
3	Emergency light	Illuminates up the escape route	
4	Alarm LED	Red	Alarm or fault
		Orange	Process or update
		Green	Audible signal
5	Alarm	Acoustic signal	
6	Mounting plate	-	
7	Emergency light marking	Helps during installation to direct the emergency light towards the escape route	

5.0 INSTALLATION AND SETUP

i Before you start
Please ensure that you have a Bosch Smart Home Controller and the Bosch Smart Home App, and that you have set both of them up successfully.

▶ You can also watch easy to follow installation videos on our website:
www.bosch-smarthome.com/installation

5.1 Installation



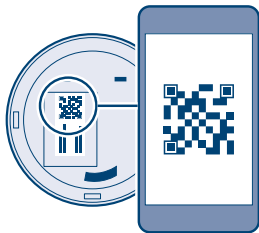

Start the Bosch Smart Home App and select “Add device”.



The app will prompt you to scan the QR code found on the back of the smoke alarm.



5.2 Activating the device

The next step in the app is the activation of the smoke alarm. Twist the smoke alarm into the mounting plate.

-  The smoke alarm is operational once it is twisted into the mounting plate. Please note that inadvertently pressing the operating button will trigger a test alarm.
-  From this point, the app guides you through the installation process. You will find a detailed description in this instruction manual.

6.0 MOUNTING THE SMOKE ALARM

6.1 Mounting instructions

-  It is best practice to install several smoke alarms in your home to be fully protected. As a minimum we recommend that they are installed in every bedroom, kids room and in all hallways that serve as an escape route. For the maximum effectiveness we recommend that additional smoke alarms should be installed in living areas, attics and basements.
-  In order to prevent injury, the mounting instructions in this instruction manual must be followed and the general safety regulations observed.



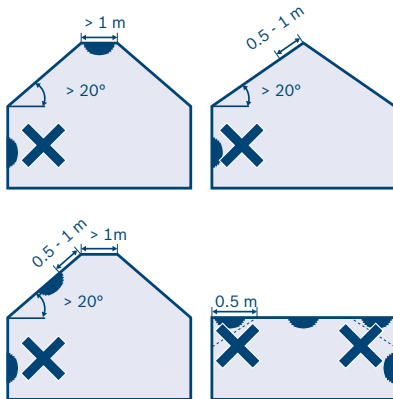
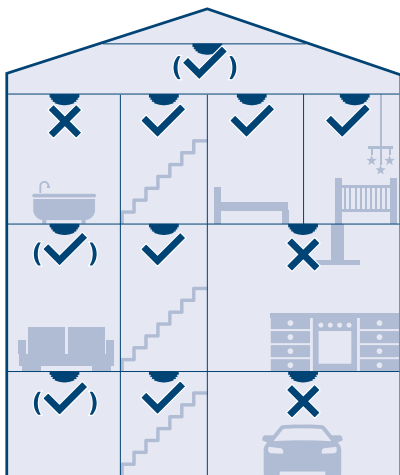

The smoke alarm should be mounted on ceilings (or on the ceiling), the diagrams above gives guidance on best practice for installation locations.

6.2 Fixing with screws

! When choosing a mounting location and when drilling, pay attention to potential electrical cables and/or pipes that could be behind the wall.

The app will guide you through the following mounting steps. You can choose between mounting with either the screws or the adhesive strip. Ensure you have positioned the emergency light in the desired position.

i There is a round recess on the inside of the mounting plate. This shows the position of the emergency light.

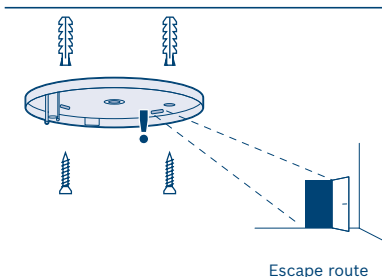
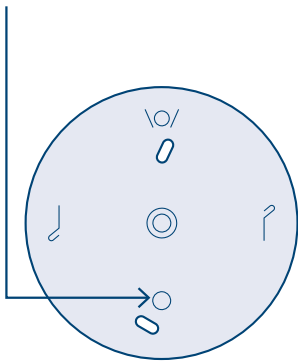

- ▶ Hold the mounting plate in the desired position ensuring the emergency light is in the correct orientation
- ▶ Mark the drill holes
- ▶ Drill the holes and insert the plugs
- ▶ Position the mounting plate and screw in place

6.3 Fixing with adhesive tapes

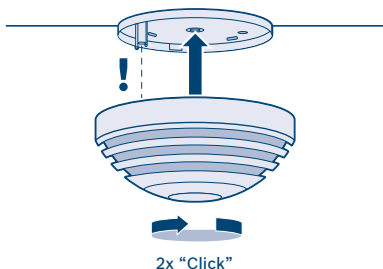

- ▶ Now twist the smoke alarm into the mounting plate

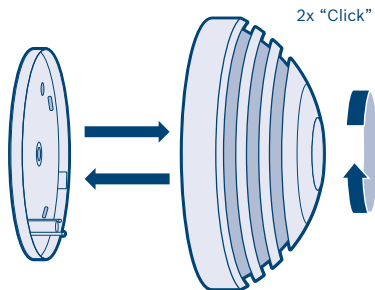

- ▶ Twist the smoke alarm into the mounting plate

! Please note when firmly pressing the smoke alarm with the mounting plate against the ceiling that inadvertently pressing the operating button will trigger a test alarm.

! Mounting with adhesive strips is only suitable for very smooth even surfaces. Woodchip wallpaper, rough plaster or coated concrete etc. are not suitable.

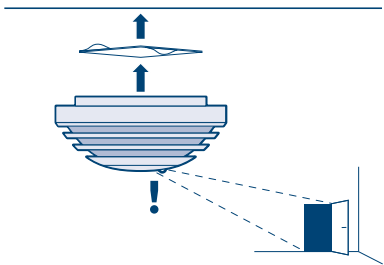

- ▶ Attach the adhesive strip to the mounting plate and peel off the second protective film
- ▶ Make sure the emergency light is pointing towards the escape route
- ▶ Now press the smoke alarm with mounting plate attached firmly against the ceiling

6.4 Functional test

We recommend that you test your smoke alarm immediately following installation and then again every month after.

- ▶ To do so, briefly press the operating button or start a functional test via the app.

The alarm will sound three times, the alarm LED will flash red and the emergency light will light up. Following a successful test the alarm LED flashes red every 10 seconds for 10 minutes. During this time the product will be muted.

If the signals described do not occur, the product is faulty. If this is the case, replace the product.

 After a functional test or switching off the alarm, smoke detection will be deactivated for 10 minutes and the product will be muted.

 There must be a functioning wireless network and internet connection in order for warnings to be sent in the event of a potential fire. Robert Bosch Smart Home GmbH is not able to offer a guarantee on the time it will take for this notification to be transmitted.

 Please note that the emergency services number stored in the app will not be automatically called if the smoke alarm detects smoke. If necessary, you always have to call the emergency services yourself!

 You need to ensure that your mobile device is on and connected to a mobile communications network in order for it to receive warnings and notifications from the Smart Home Smoke Alarm.

7.0 MAINTENANCE INSTRUCTIONS

 We recommend you inspect and test your smoke alarm on a monthly basis.

7.1 Visual inspection

- ▶ The smoke inlet openings along the sides and the sound outlets are not clogged (e. g. by dust, dirt or paint).
- ▶ If necessary, clean the smoke alarm carefully with a damp cloth.
- ▶ Check for any damage and that the plate is still firmly fixed in place.
- ▶ Ensure that there is a clear space of 0.5 m around your smoke alarm so smoke detection is not hindered (e. g. by furnishing).

8.0 ALARM AND TROUBLESHOOTING

8.1 Switching off the alarm

- i** If you have multiple smoke alarms installed, an alarm can only be muted on the alarm that detected the potential fire. This can be identified by the red flashing LED.
- Pressing the operating button on the triggering device will silence all other alarms at the same time.

8.2 Faults and measures

Audible signal	Visual signal	Cause	Fix
The alarm sounds once every 43 seconds.	The LED flashes red once every 43 seconds.	The battery level is low.	The battery itself cannot be replaced, the smoke alarm should be replaced.

9.0 PRODUCT DETAILS

9.1 Technical data

Device type name	Bosch Smart Home Smoke Detector
Classification	Wireless smoke alarm
Rated voltage	3 V lithium batteries (not replaceable)
Battery life	> 10 Jahre (typisch) ¹⁾
Type of protection	IP20
Ambient temperature	+5 °C to +55 °C
Storage temperature	-5 °C to +30 °C, 55 °C (for a short term, maximum of 14 days in total)
Max. transmitting capacity	10 mW
Radio frequency	868.3 MHz, 869.525 MHz
Wireless free-field range	≥ 100 m
Receiver category	SRD category 2
Duty Cycle	At 868.3 MHz < 1% per h At 869.525 MHz < 10% per h
Maximum number of connectable devices	40
Volume at a distance of 3 m	> 85 dB(A)
Software class	Class A
Casing dimensions (W × H × D)	119 mm × 51 mm
Weight	150 g

¹⁾ 10 years based on typical storage temperature (-5 °C to +30 °C), typical battery temperature (-5 °C to +30 °C) and monthly functional test. High temperatures above 30 °C reduce the service life.

9.2 Declaration of conformity

Hereby, Robert Bosch Smart Home GmbH declares that the radio equipment type Bosch Smart Home Smoke Alarm is in compliance with Directive 2014/53/EU. The full text of the EU declaration of conformity is available at the following internet address: www.bosch-smarthome.com/conformity



9.3 Faults in radio operation

Faults in radio operation (e.g. due to electric motors or defective electrical devices) cannot be ruled out. The radio range inside buildings may differ greatly from the radio range in free-field conditions. Apart from the transmission power and the receiver characteristics, environmental influences such as humidity and structural characteristics may also influence radio operation.

9.4 Open-source software

This Bosch Smart Home product uses open-source software. You will find the license information for the components used on the opposite site.

core_cm3.h

Copyright (C) 2009-2013 ARM Limited. All rights reserved. Redistribution and use in source and binary forms, with or without modification, are permitted provided that the following conditions are met:

Redistributions of source code must retain the above copyright notice, this list of conditions and the following disclaimer.

Redistributions in binary form must reproduce the above copyright notice, this list of conditions and the following disclaimer in the documentation and/or other materials provided with the distribution. Neither the name of ARM nor the names of its contributors may be used to endorse or promote products derived from this software without specific prior written permission.

THIS SOFTWARE IS PROVIDED BY THE COPYRIGHT HOLDERS AND CONTRIBUTORS „AS IS“ AND ANY EXPRESS OR IMPLIED WARRANTIES, INCLUDING, BUT NOT LIMITED TO, THE IMPLIED WARRANTIES OF MERCHANTABILITY AND FITNESS FOR A PARTICULAR PURPOSE ARE DISCLAIMED. IN NO EVENT SHALL THE COPYRIGHT OWNER OR CONTRIBUTORS BE LIABLE FOR ANY DIRECT, INDIRECT, INCIDENTAL, SPECIAL, EXEMPLARY, OR CONSEQUENTIAL DAMAGES (INCLUDING, BUT NOT LIMITED TO, PROCUREMENT OF SUBSTITUTE GOODS OR SERVICES; LOSS OF USE, DATA, OR PROFITS; OR BUSINESS INTERRUPTION) HOWEVER CAUSED AND ON ANY THEORY OF LIABILITY, WHETHER IN CONTRACT, STRICT LIABILITY, OR TORT (INCLUDING NEGLIGENCE OR OTHERWISE) ARISING IN ANY WAY OUT OF THE USE OF THIS SOFTWARE, EVEN IF ADVISED OF THE POSSIBILITY OF SUCH DAMAGE.

9.5 Environmental protection and disposal

Electrical and electronic equipment that is no longer usable or is defective, or used batteries must be separated from other waste and recycled in an environmentally friendly manner (European Directive on Waste Electrical and Electronic Equipment). To dispose of old electrical and electronic equipment or batteries, use your country-specific return and collection systems.

Batteries must not be disposed of with household waste. Used batteries must be disposed of in the local collection systems.



10.0 FURTHER INFORMATION

You can find more detailed information on operating and maintaining the smoke alarm in the online FAQs at www.bosch-smarthome.com/service. You will also find all contact details on the rear side of this document.

- i** **Sale and transfer**
Before you transfer or sell your device, delete your personal information. To do this, reset the device to its factory settings (see online FAQs).

 Robert Bosch Smart Home GmbH
Schockenriedstraße 17
70565 Stuttgart, Germany

 0808 1011 151* (United Kingdom) and
1800 200 724* (Ireland)

* Freephone service

Mon–Fri 7 am – 8 pm
Sat/Sun 8 am – 6 pm

 service@bosch-smarthome.com